

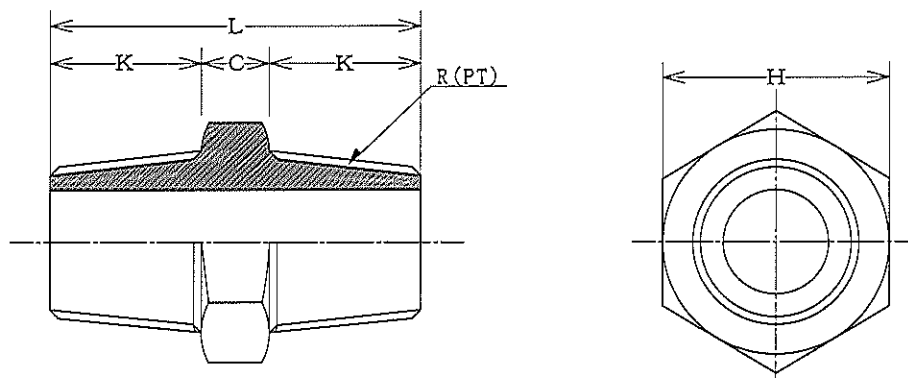

ねじ込み形ニップル
THREADED NIPPLES

SN
(NIPPLES)

ステンレス用
FOR STAINLESS STEEL



S N

UNIT : mm

NOM. SIZE		Rc (PT)	K	C	L	H
(A)	(B)					
8	1/4	1/4	15.0	5.0	35.0	17.0
10	3/8	3/8	15.0	7.0	37.0	19.0
15	1/2	1/2	17.0	9.0	43.0	23.0
20	3/4	3/4	20.0	9.0	49.0	29.0
25	1	1	22.0	10.0	54.0	35.0
32	1-1/4	1-1/4	22.0	12.0	56.0	46.0
40	1-1/2	1-1/2	25.0	12.0	62.0	50.0
50	2	2	29.0	14.0	72.0	63.0

ヤマト特殊鋼株式会社
YAMATO SPECIAL STEEL CO., LTD.

Sheet No. JST-10

平成22年1月5更新