

Draw Latches

The number next to the logo mark indicates items in stock for each brand.

Machine Tools

O-Rings
Oil
Seals

Rubbers

Resins

Metal
Materials

Carbon
Fibers

Ceramic
Materials

Vibration
Absorber

Adjusters

Plungers

Springs
for
Die

Springs

Split
Pins

Snap
Rings

Oil
Gauges

Oil
Tank
Caps

Knobs

Lever

Handles
Grips

Handles

Hinges

Slide
Rails

Stays

Toggle
Latches

Fastening
Parts

Aluminum
Frames



Draw Latch (sideways displacement prevention type, steel)



- Specs**
- Body Mounting Hole Dimension: 2.6mm
 - Receiving Hole Dimension: 2.6mm
- Materials**
- Cold Rolled Steel Plate (SPCC)
 - Surface Treatment: Nickel-plated Finishing
- Origin**
- Japan

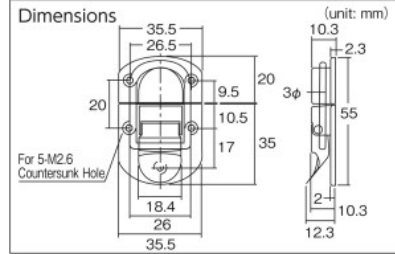

P-17



Draw Latch (sideways displacement prevention type, steel)



- Specs**
- Body Mounting Hole Dimension: 3.4mm
 - Receiving Hole Dimension: 3.4mm
- Materials**
- Cold Rolled Steel Plate (SPCC)
 - Surface Treatment: Nickel-plated Finishing
- Origin**
- Japan

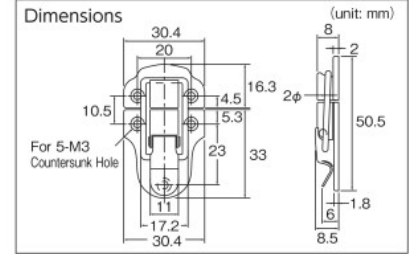

P-46

Order Unit: 1 Bag (Price revision date: Jan, 2016) TRUSCO NAKAYAMA CORPORATION

Order Code	Item No.	Price (per bag)	MSRP (per bag)	Q'ty Per Bag (piece)	SPQ (bag)	Weight (g/bag)
232-9166	P-17	¥1,306	¥1,410	4	10	120

Contact us: 0120-509-849 <http://www.orange-book.com/>

Order Unit: 1 Bag (Price revision date: Jan, 2016) TRUSCO NAKAYAMA CORPORATION

Order Code	Item No.	Price (per bag)	MSRP (per bag)	Q'ty Per Bag (piece)	SPQ (bag)	Weight (g/bag)
232-8453	P-46	¥1,555	¥1,680	4	10	80

Contact us: 0120-509-849 <http://www.orange-book.com/>



Draw Latch (sideways displacement prevention type, steel)



- Specs**
- Body Mounting Hole Dimension: 3.5mm
 - Receiving Hole Dimension: 3.5mm
- Materials**
- Cold Rolled Steel Plate (SPCC)
 - Surface Treatment: Nickel-plated Finishing
- Origin**
- Japan

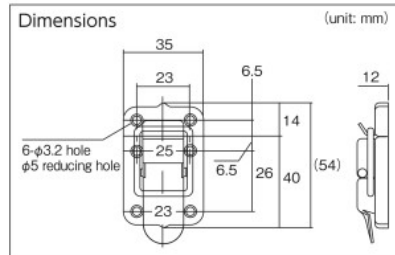

P-18

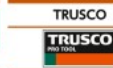

Draw Latch (sideways displacement prevention type, steel)



- Specs**
- Body Mounting Hole Dimension: 3.9mm
 - Receiving Hole Dimension: 3.9mm
- Materials**
- Cold Rolled Steel Plate (SPCC)
 - Surface Treatment: Nickel-plated Finishing
- Origin**
- Japan

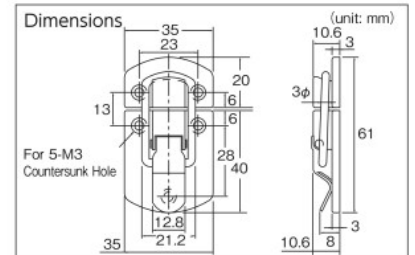

P-48

Order Unit: 1 Bag (Price revision date: Jan, 2016) TRUSCO NAKAYAMA CORPORATION

Order Code	Item No.	Price (per bag)	MSRP (per bag)	Q'ty Per Bag (piece)	SPQ (bag)	Weight (g/bag)
232-9239	P-18	¥1,037	¥1,120	4	10	130

Contact us: 0120-509-849 <http://www.orange-book.com/>

Order Unit: 1 Bag (Price revision date: Jan, 2016) TRUSCO NAKAYAMA CORPORATION

Order Code	Item No.	Price (per bag)	MSRP (per bag)	Q'ty Per Bag (piece)	SPQ (bag)	Weight (g/bag)
232-8577	P-48	¥1,638	¥1,770	4	10	180

Contact us: 0120-509-849 <http://www.orange-book.com/>



Stock 38,650 Items

Draw Latch (sideways displacement prevention type, steel)



- Materials**
- Cold Rolled Steel Plate (SPCC)
 - Surface Treatment: Trivalent Chrome-plated Finishing
- Origin**
- Japan

Body Mounting/Receiving Hole Dimension

Item No.	Hole Diameter (mm)
P-44A	3.2
P-45	3.8

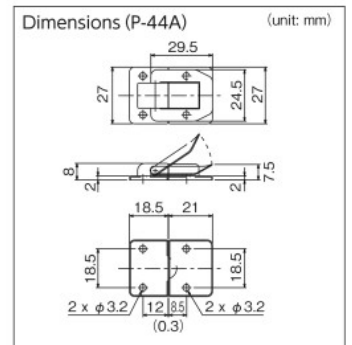
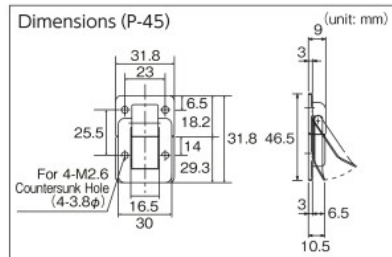

P-44A



P-45

Order Unit: 1 Bag (Price revision date: Jan, 2016) TRUSCO NAKAYAMA CORPORATION

Order Code	Item No.	Price (per bag)	MSRP (per bag)	Q'ty Per Bag (piece)	SPQ (bag)	Weight (g/bag)
827-5560	P-44A	¥ 990	¥1,070	4	10	56
232-9093	P-45	¥1,231	¥1,330	4	10	140

Contact us: 0120-509-849 <http://www.orange-book.com/>