

Prices displayed include 8% tax.

TRUSCO Stock 38,650 Items

Flat Bar Stay (steel)

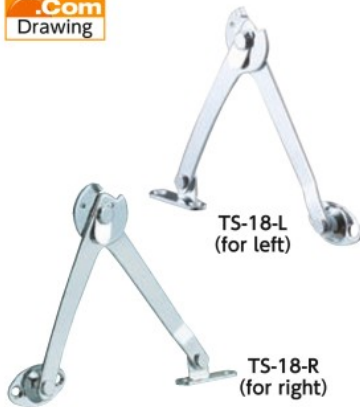

- Features**
- There is a simple stopping mechanism in the center.
- Use**
- Assistance for furniture and others.
 - Equipment casing.
- Materials**
- Cold Rolled Steel Plate (SPCC)
 - Surface Treatment: Chrome Plated Finishing
- Origin**
- Japan

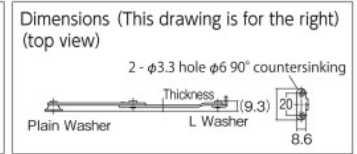
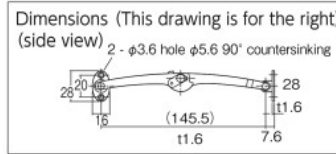

Order Unit: 1 Piece

(Price revision date: Jan, 2016) TRUSCO NAKAYAMA CORPORATION

Order Code	Item No.	Price (per piece)	MSRP (per piece)	Designation	Total Length (mm)	Thickness (mm)	Hole Diameter (mm)	Hole Number	SPQ (piece)	Weight (g)
302-1971	TS-18-L	¥685	¥740	For left	146	1.6	3.6 (plain washer), 3.3 (L washer)	2 (plain washer), 2 (L washer)	10	31
302-1980	TS-18-R	¥685	¥740	For right	146	1.6	3.6 (plain washer), 3.3 (L washer)	2 (plain washer), 2 (L washer)	10	31

Contact us: 0120-509-849 <http://www.orange-book.com/>

TRUSCO Stock 38,650 Items

Stopper-equipped Flat Bar Stay (steel)



- Features**
- A simple structure to install.
- Use**
- Assistance for furniture and others.
 - Equipment casing.
- Materials**
- Cold Rolled Steel Plate (SPCC)
 - Surface Treatment: Nickel-plated Finishing
- Origin**
- Japan

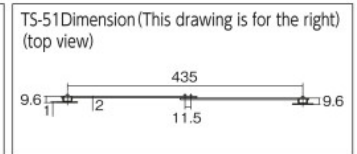
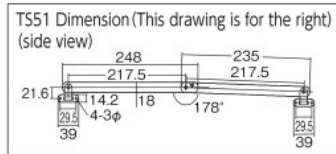
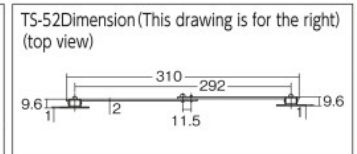
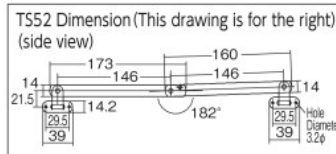
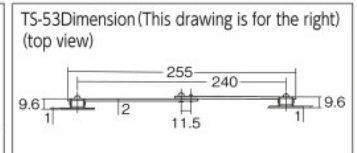
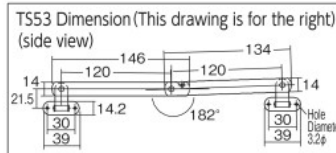

Order Unit: 1 Piece

(Price revision date: Jan, 2016) TRUSCO NAKAYAMA CORPORATION

Order Code	Item No.	Price (per piece)	MSRP (per piece)	Designation	Total Length (mm)	Thickness (mm)	Hole Diameter (mm)	Hole Number	SPQ (piece)	Weight (g)
302-1955	TS-53-L	¥593	¥640	For left	240	2	3.2 (plain washer)	4 (plain washer)	10	82
302-1939	TS-52-L	¥630	¥680	For left	300	2	3.2 (plain washer)	4 (plain washer)	10	93
302-1912	TS-51-L	¥713	¥770	For left	450	2	3.2 (plain washer)	4 (plain washer)	10	154
302-1963	TS-53-R	¥593	¥640	For right	240	2	3.2 (plain washer)	4 (plain washer)	10	82
302-1947	TS-52-R	¥630	¥680	For right	300	2	3.2 (plain washer)	4 (plain washer)	10	93
302-1921	TS-51-R	¥713	¥770	For right	450	2	3.2 (plain washer)	4 (plain washer)	10	154

Contact us: 0120-509-849 <http://www.orange-book.com/>

TRUSCO Stock 38,650 Items

Flat Bar Sliding Stay (steel)



- Features**
- A stopping mechanism where the shaft falls into a groove in the rail and stops.
- Use**
- Assistance for furniture and others.
 - Equipment casing.
- Materials**
- Cold Rolled Steel Plate (SPCC)
 - Surface Treatment: Nickel-plated Finishing
- Origin**
- Japan

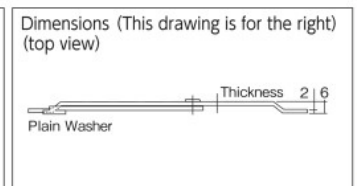
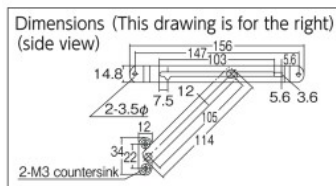

Order Unit: 1 Piece

(Price revision date: Jan, 2016) TRUSCO NAKAYAMA CORPORATION

Order Code	Item No.	Price (per piece)	MSRP (per piece)	Designation	Total Length (mm)	Thickness (mm)	Hole Diameter (mm)	Hole Number	SPQ (piece)	Weight (g)
302-1904	TS-03-L	¥630	¥680	For left	147	2	4 (plain washer), 3.5 (body)	2 (plain washer), 2 (body)	10	55
302-1891	TS-03-R	¥630	¥680	For right	147	2	4 (plain washer), 3.5 (body)	2 (plain washer), 2 (body)	10	55

Contact us: 0120-509-849 <http://www.orange-book.com/>